

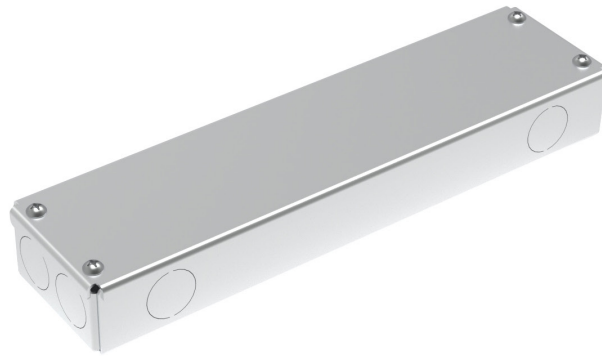

Project : _____ Firm : _____ Type : _____ Quantity: _____



Quick Specs

Driver Type	Constant Current
Dimming Control	0-10 / Phase
# of Channels	1
DC Voltage Range	28-42 VDC
AC Input Voltage	120 - 277
Class	2
mA	350 - 700
Wattage	29.4
Warranty	5 years
Efficiency	>90%

Max Load (700mA)

Super Low (50mA)	14 Feet
Low (89mA)	7 Feet
Medium (149mA)	4 Feet
High (250mA)	3 Feet
Super High (300mA)	3 Feet

Max Distance

20 AWG	20 Feet
18 AWG	40 Feet
16 AWG	60 Feet
14 AWG	100 Feet
12 AWG	150 Feet





Driver Anatomy

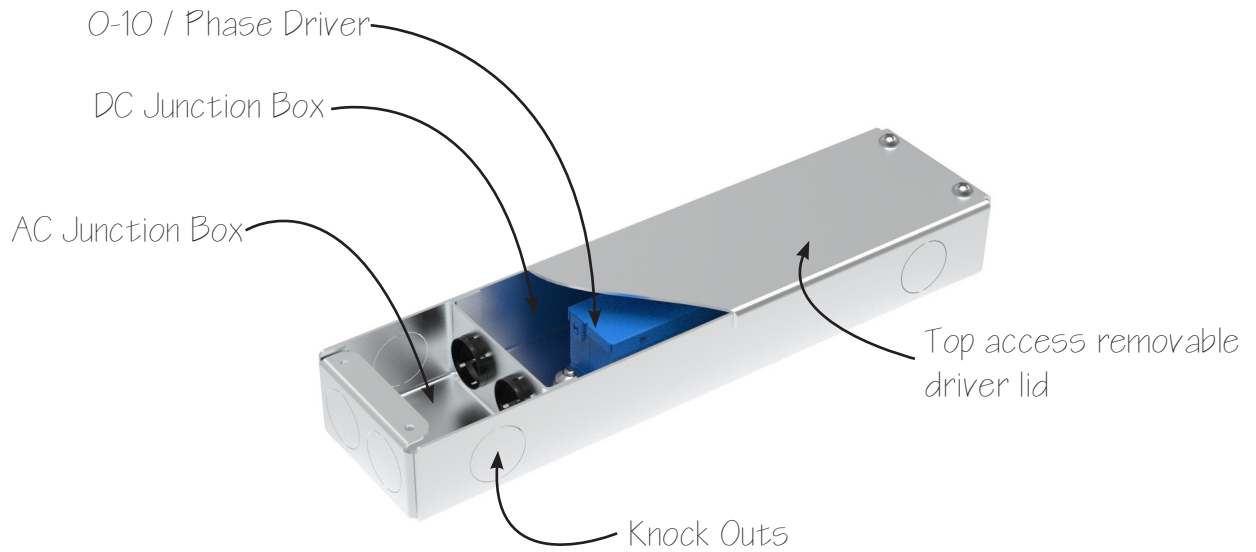

Dimensions

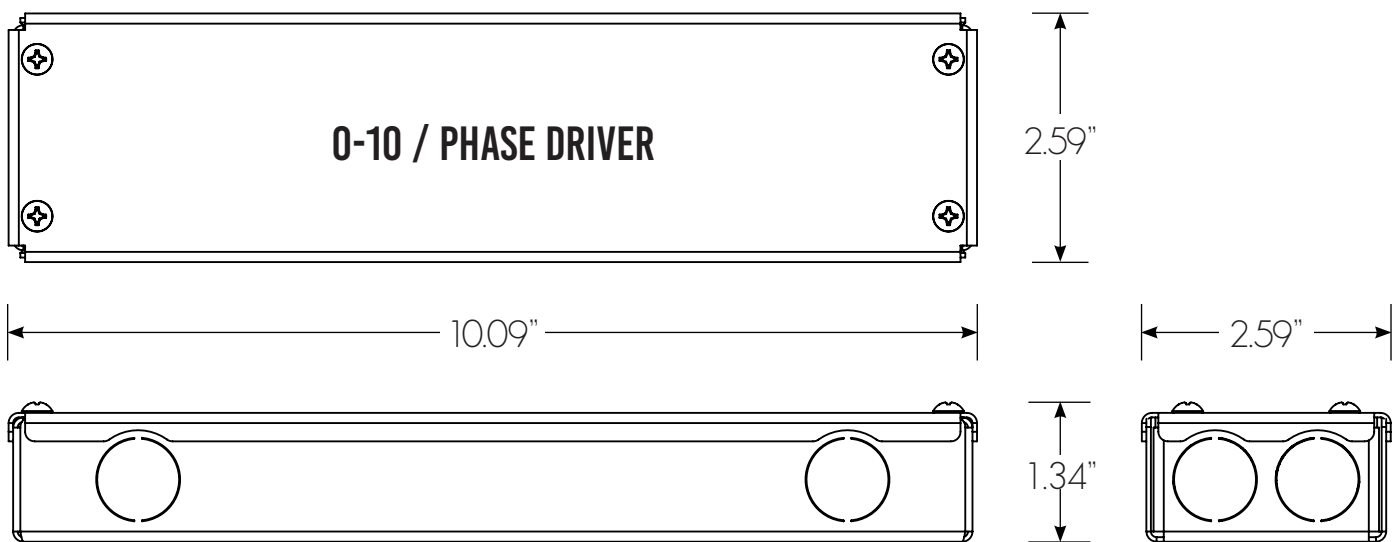



0-10 Wiring

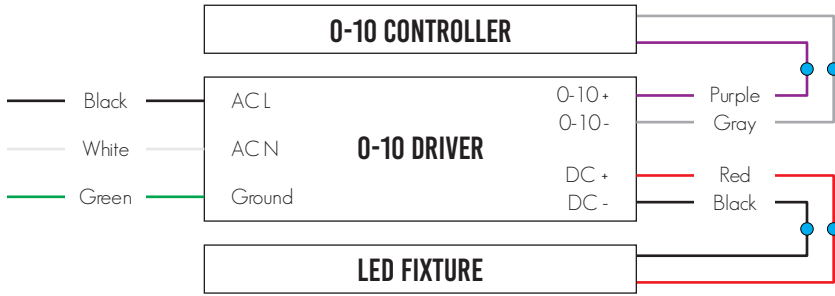

Single 0-10 wiring

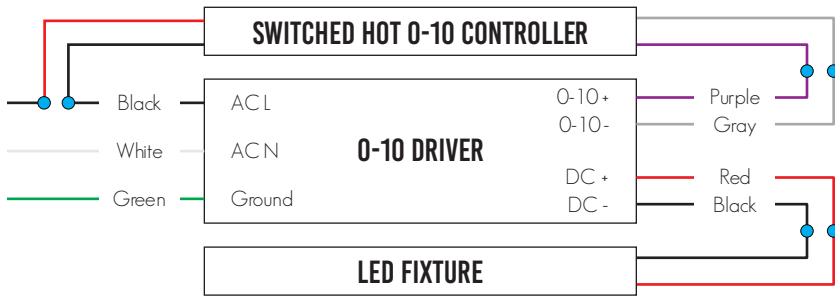

Switched Hot 0-10 Wiring

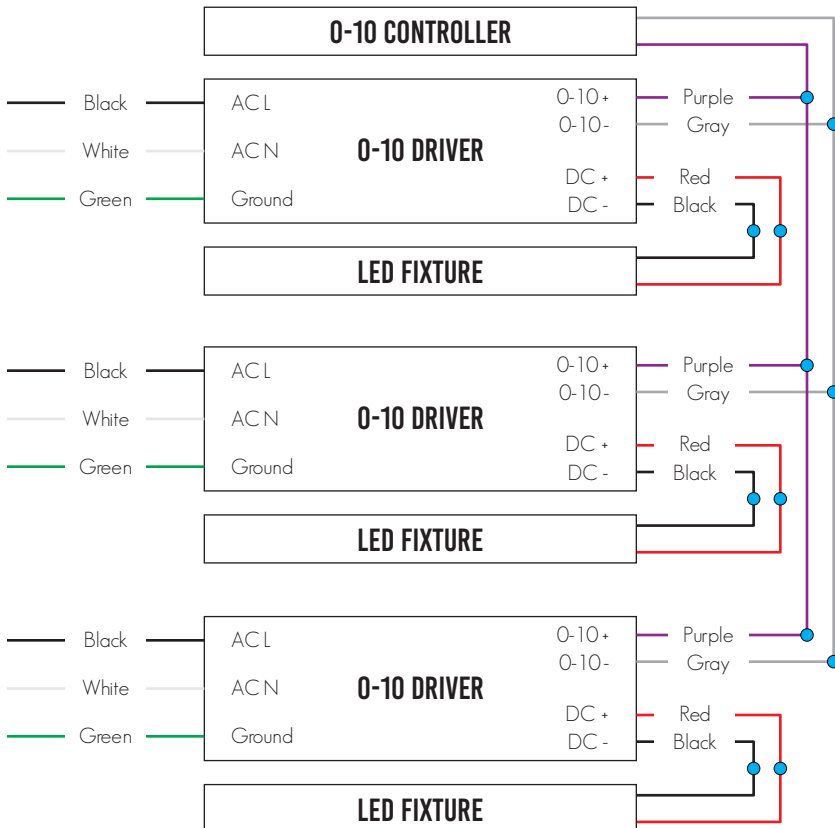

Multiple fixture wiring to single 0-10 Dimmer





Phase Wiring

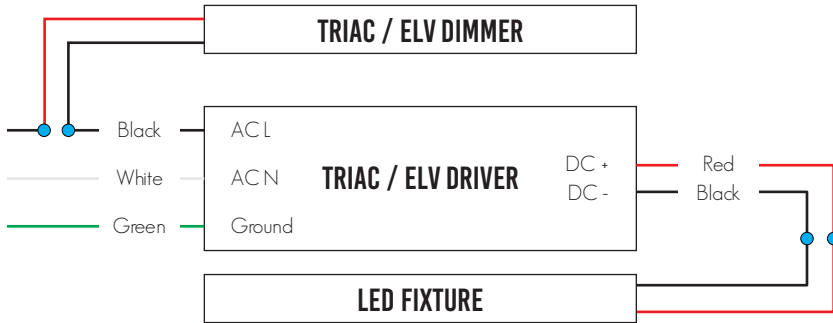

Single Phase wiring

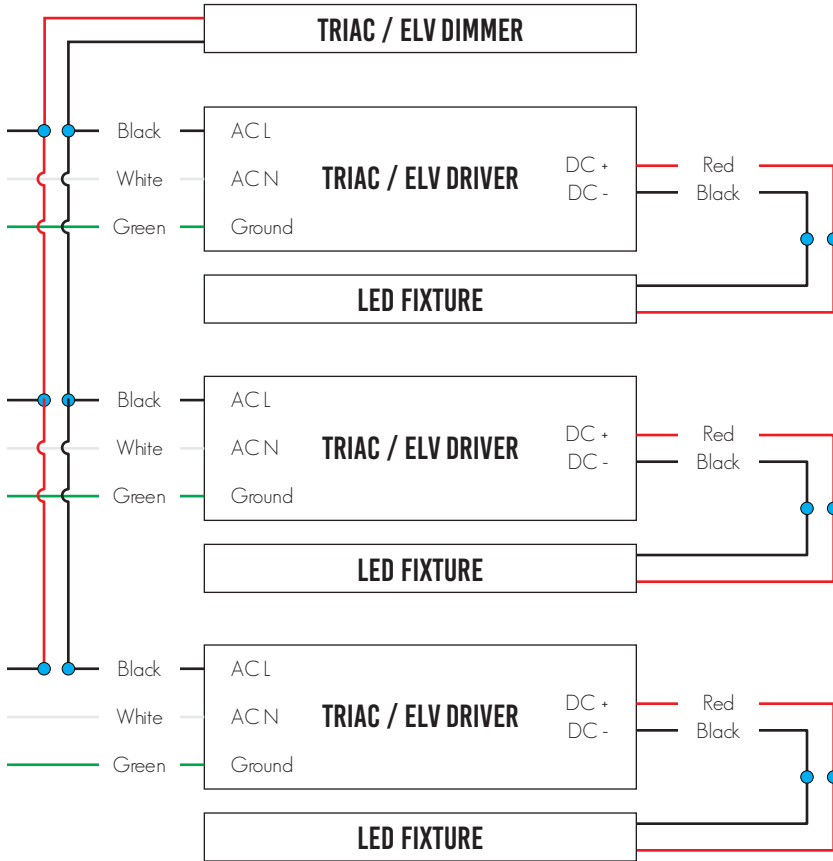

Multiple fixture wiring to single phase Dimmer

