

# Suspended Reveal

SCOUT

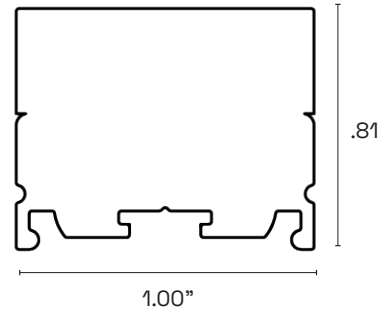

## Dimensions



## Optics

Square Milky

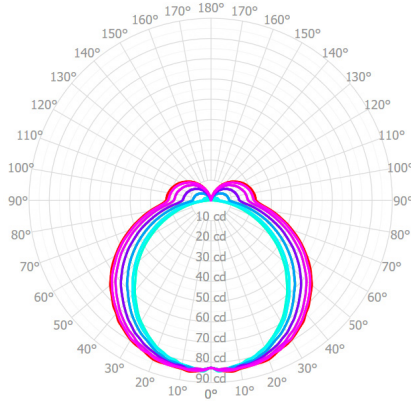

## Spec Lock

- LED specially binned through forward voltage within a 3-step MacAdam ellipse for increased CCT fidelity and smooth lower end dimming.
- Mechanically fastened Rigid PCB set within an extruded aluminum channel for simple installation and total serviceability.
- Pressure fit metal pin connection for solderless in-field connection between LED boards for a seamless appearance.
- Flexible power feed injections maintain LED pitch consistency for a plethora of mounting options.
- Never a shadow, hotspot nor break in light no matter the output and run length.
- No double-sided adhesion (tape) or soldering during installation.



# Suspended Reveal

SCOUT

## Part # Builder

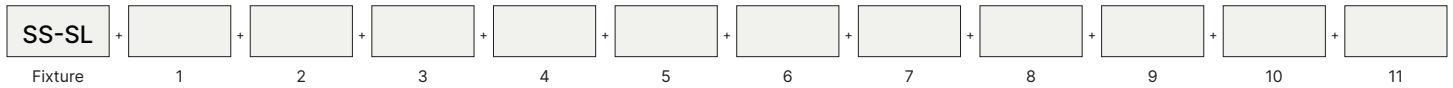

Fixture	1 : Lens	2 : Intensity <sup>1</sup>	3 : Color Temp
SS-SL : Reveal	SQM : Square Milky	SL : Super Low (219lm/1.6w per ft) L : Low (388lm/2.8w per ft) M : Medium (644lm/4.8w per ft) H : High (1092lm/8.3w per ft) LD : LumenDial (Consult Factory)	22 : 2200K 27 : 2700K 30 : 3000K 35 : 3500K 40 : 4000K 50 : 5000K TW2235: 22K-35K TW2235: 27K-50K
4 : Finish <sup>2</sup>	5 : Feed <sup>3</sup>	6 : Control	7 : Mounting
M : Mill Finish W : Gloss White (Cost Adder) B : Matte Black (Cost Adder) C : Custom RAL# (Cost Adder - Consult Factory)	RF : Rear Feed	0 : None 1 : 0-10 -1% Dimming 2 : 0-10 - 0.1% Dimming 3 : DMX/ DALI 4 : POE 5 :ELV / MLV / Phase 6 : 0-10 Tuneable White 7 : 0-10 Warm Dim 8 : Lutron Hi-Lume 1% Ecosystem W/ SO-FTB 9: Lutron Hi Lume 1% 3 Wire + G 10: Lutron Athena Wireless Node - RF Only 11: Casambi 12: nLyte 13: Enlighted 14: Other - Consult Factory	PH : Pendant Hung
8 : Blind Cove <sup>4</sup>	9 : Wire Length	10 : Shape	11 : Fixture Length
Y : Yes N : No	12" 24" 48" 96" Custom - (Consult Factory)	S - Straight U - U Shape L - L Shape R - Rectangle P - Pattern (Consult Factory)	X' Y"

### Square Milky

OUTPUT	SL	L	M	H	SH
Lumens/Foot	115	204	339	575	670
Watts/ Foot	1.6	2.8	4.8	8.3	9.8
Lumens/Watt	73	72	71	69	68



Driver Wiring



Installation Guide

## Specification Details

	LENS	LIGHT LOSS	VISIBLE DIODES	SUPER LOW	LOW	MEDIUM	HIGH	SUPER HIGH
Watts / Foot	N/A			1.6	2.8	4.8	8.3	9.8
mA / Foot	N/A			50	89	149	256	300
Frosted Lens: Lumens / Foot	Frosted	5%	Yes	219	388	644	1092	1273
Frosted Lens: Lumens / Watt <sup>1</sup>	Frosted	5%	Yes	139	138	135	131	129
Milky Lens: Lumens / Foot	Milky	50%	No	115	204	339	575	670
Milky Lens: Lumens / Watt <sup>1</sup>	Milky	50%	No	73	72	71	69	68
0-10 / Lutron Athena Node	Max Output 2000mA			40 Feet	22 Feet	13 Feet	8 Feet	5 Feet
DMX / DALI	Max Output 1500mA			21 Feet	11 Feet	7 Feet	4 FeetW	3 Feet
Phase	Max Output 700mA			14 Feet	7 Feet	4 Feet	2 Feet	2 Feet
POE	Consult Factory							
Lutron Drivers	LDE1 Hi-Lume 1% EcoSystem. Soft On Fade to Black			L3DA3W Hi-Lume 1% 3 WIRE+G				
Color Temperatures (K) + Flux	2200 (82%), 2700 (100%), 3000 (100%), 3500 (115%), 4000 (118%), 5000 (106%)							
CRI	90+							
R9	50+							
MacAdams Ellipses	3 Steps							
Beam Angle <sup>2</sup>	120 Degrees							
IP Rating	IP20 - Dry Location							
Lamp Life	50,000 Hours							
/Dimming / Control <sup>3</sup>	0-10 / POE / DMX / DALI / PHASE / "LUTRON / LUTRON WIRELESS"							
Operating Temperature	-13°F to 122°F							

### FINISH

Standard Mill Aluminum Finish.  
Powder Coating to any RAL# available upon specification  
Increased pricing for powder coating.

### Warranty

2 Year Limited Warranty - Covers all Scout manufactured products.  
Default to manufactures warranty for all 3rd party components. Does not cover labor.

### ORDER DETAILS

- All fixtures come standard with starter end cap feed unless otherwise specified.
- All Scout Select Fixtures come preassembled up to 8 feet long with 8" power feed.
- Any Fixture length under 8 feet long will be made as a complete fixture.
- Any Fixture length over 8 feet long will be broken into 6 foot lengths + the balance length. A 10 Foot Fixture will be broken into 1 length @ 6 Feet and 1 @ 4 Feet.
- Fixtures daisy chain together with Scout\_Lock™ Technology.
- In situations where fixtures are longer than the maximum wattage load new power will be injected from either the side or rear. Standard Injection is side Feed 1.
- All orders come with an approval drawing. Fabrication will not begin until drawing has been signed off or waived.

<sup>1</sup>Lumens / Watt accounts nominal driver efficacy at full load

<sup>2</sup> Finish: Mill Finish comes standard. Cost Adder for Power Coating. Contact Factory for Custom RAL#

<sup>3</sup>Feed: See Feed Details on page 4

### LED SYSTEM

Proprietary linear LED Scout Engine incorporates premium Cree LEDs on a robust platform to achieve excellent thermal management. LEDs are placed to promote a uniform appearance.  
Available in 2200K, 2700K, 3000K, 3500K, 4000K or 5000K in 90+ CRI. LED modules and drivers are replaceable.  
Color accuracy <3 SDCM

### CONSTRUCTION

One piece extruded aluminum housing. Cast aluminum end caps.

### OPTICS

Extruded High Transmission Milky Acrylic Lens with No LED imaging. Extruded High Transmission Frosted Acrylic Lens with LED imaging.

### ELECTRICAL

Fixture comes reassembled with 8" whip.  
All Drivers are installed in remote location.  
All drivers are Universal input 120-277 VAC.  
Standard Constant Current drivers include 0-10V dimming preinstalled in enclosure.

### LABELS

Conforms To UL STD 2108 Certified To CSA STD C22.2 # 250.0  
Suitable for Dry or Damp Locations, indoor use only.  
ETL Control # 5011600

# Suspended Reveal

SCOUT

## Feed Points

Rear Feed

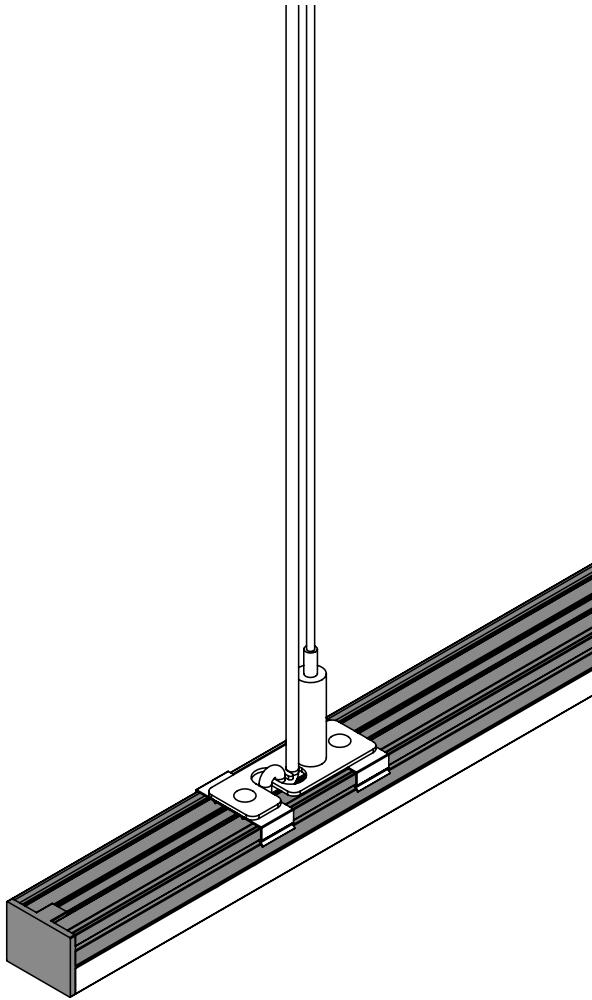

## Mounting Clips

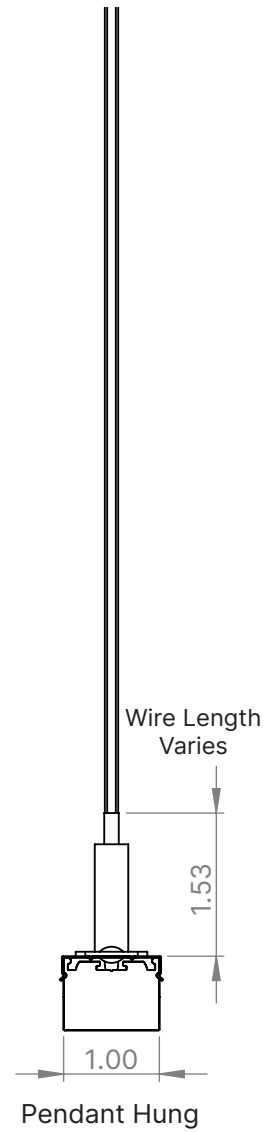

## Patterns

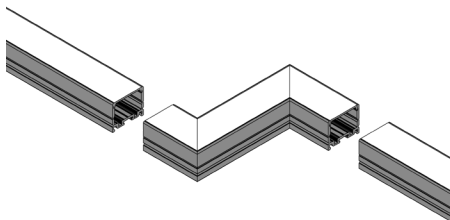

Custom patterns

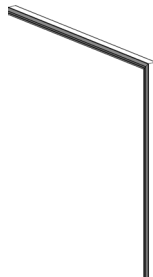

Changing elevations

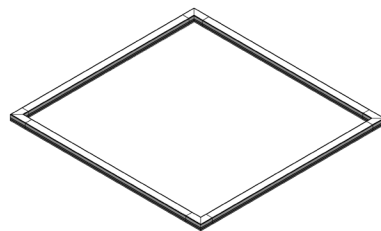

Coplanar surfaces