

Dimensions

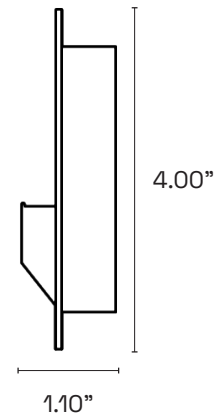

Optics

Flat Frosted

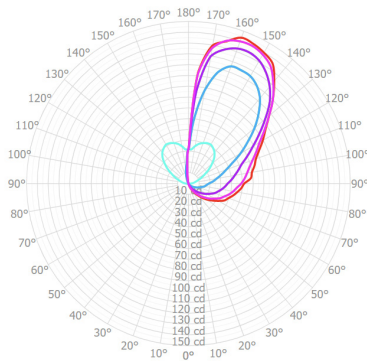

Spec Lock

- LED specially binned through forward voltage within a 3-step MacAdam ellipse for increased CCT fidelity and smooth lower end dimming.
- Mechanically fastened Rigid PCB set within an extruded aluminum channel for simple installation and total serviceability.
- Pressure fit metal pin connection for solderless in-field connection between LED boards for a seamless appearance.
- Flexible power feed injections maintain LED pitch consistency for a plethora of mounting options.
- Never a shadow, hotspot nor break in light no matter the output and run length.
- No double-sided adhesion (tape) or soldering during installation.



LightSlice Pucks

SCOUT

Part # Builder

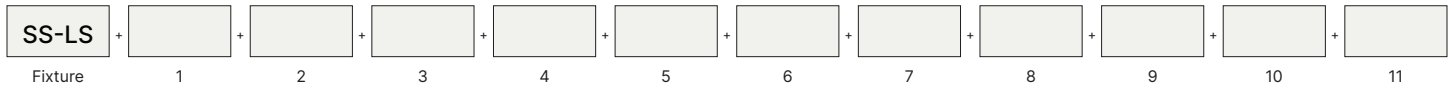

Fixture	1 : Lens	2 : Intensity ¹	3 : Color Temp
SS-LS : LightSlice Pucks	FF : Flat Frosted Visible Diode: 5% Light Loss	SL : Super Low (219lm/1.6w per ft) L : Low (388lm/2.8w per ft) M : Medium (644lm/4.8w per ft) H : High (1092lm/8.3w per ft) LD : LumenDial (Consult Factory)	22 : 2200K 27 : 2700K 30 : 3000K 35 : 3500K 40 : 4000K 50 : 5000K TW2235: 22K-35K TW2750: 27K-50K
4 : Finish ²	5 : Feed ³	6 : Control	7 : Mounting
M : Mill Finish W : Gloss White (Cost Adder) B : Matte Black (Cost Adder) C : Custom RAL# (Cost Adder - Consult Factory)	RF : Rear Feed	0 : None 1 : 0-10 -1% Dimming 2 : 0-10 - 0.1% Dimming 3 : DMX/ DALI 4 : POE 5 :ELV / MLV / Phase 6 : 0-10 Tuneable White 7 : 0-10 Warm Dim 8 : Lutron Hi-Lume 1% Ecosystem W/ SO-FTB 9 : Lutron Hi Lume 1% 3 Wire + G 10: Lutron Athena Wireless Node - RF Only 11: Casambi 12: nLyte 13: Enlighted 14: Other - Consult Factory	W : Wall
8 : Blind Cove ⁴	9 : Wire Length	10 : Shape	11 : Fixture Length
Y : Yes N : No	12" 24" 48" 96" Custom - (Consult Factory)	S - Straight U - U Shape L - L Shape R - Rectangle P - Pattern (Consult Factory)	0' 3" 0' 6" 0' 9" 1' 0"

Flat Frosted : Visible Diodes - 5% Light Loss

OUTPUT	SL	L	M	H	SH
Lumens/Foot	219	388	644	1092	1273
Watts/ Foot	1.6	2.8	4.8	8.3	9.8
Lumens/Watt	139	138	135	131	129



Driver Wiring



Installation Guide

Specification Details

	LENS	LIGHT LOSS	VISIBLE DIODES	SUPER LOW	LOW	MEDIUM	HIGH	SUPER HIGH
Watts / Foot	N/A			1.6	2.8	4.8	8.3	9.8
mA / Foot	N/A			50	89	149	256	300
Frosted Lens: Lumens / Foot	Frosted	5%	Yes	219	388	644	1092	1273
Frosted Lens: Lumens / Watt ¹	Frosted	5%	Yes	139	138	135	131	129
0-10 / Lutron Athena Node	Max Output 2000mA			40 Feet	22 Feet	13 Feet	8 Feet	5 Feet
DMX / DALI	Max Output 1500mA			21 Feet	11 Feet	7 Feet	4 FeetW	3 Feet
Phase	Max Output 700mA			14 Feet	7 Feet	4 Feet	2 Feet	2 Feet
POE	Consult Factory							
Lutron Drivers	LDE1 Hi-Lume 1% EcoSystem. Soft On Fade to Black			L3DA3W Hi-Lume 1% 3 WIRE+G				
Color Temperatur750s (K) + Flux	2200 (82%), 2700 (100%), 3000 (100%), 3500 (115%) , 4000 (118%), 5000 (106%)							
CRI	90+							
R9	50+							
MacAdams Ellipses	3 Steps							
Beam Angle ²	120 Degrees							
IP Rating	IP20 - Dry Location							
Lamp Life	50,000 Hours							
Dimming / Control ³	0-10 / POE / DMX / DALI / PHASE / LUTRON / LUTRON WIRELESS							
Operating Temperature	-13°F to 122°F							

FINISH

Standard Mill Aluminum Finish.
Powder Coating to any RAL# available upon specification
Increased pricing for powder coating.

Warranty

2 Year Limited Warranty - Covers all Scout manufactured products.
Default to manufactures warranty for all 3rd party components. Does not cover labor.

ORDER DETAILS

- All fixtures come standard with starter end cap feed unless otherwise specified.
- All Scout Select Fixtures come preassembled up to 8 feet long with 8" power feed.
- Any Fixture length under 8 feet long will be made as a complete fixture.
- Any Fixture length over 8 feet long will be broken into 6 foot lengths + the balance length. A 10 Foot Fixture will be broken into 1 length @ 6 Feet and 1 @ 4 Feet.
- Fixtures daisy chain together with Scout_Lock™ Technology.
- In situations where fixtures are longer then the maximum wattage load new power will be injected from either the side or rear. Standard Injection is side Feed 1.
- All orders come with an approval drawing. Fabrication will not begin until drawing has been signed off or waived.

¹Lumens / Watt accounts nominal driver efficacy at full load

² Finish: Mill Finish comes standard. Cost Adder for Power Coating. Contact Factory for Custom RAL#

³Feed: See Feed Details on page 4

LED SYSTEM

Proprietary linear LED Scout Engine incorporates premium Cree LEDs on a robust platform to achieve excellent thermal management. LEDs are placed to promote a uniform appearance.
Available in 2200K, 2700K, 3000K, 3500K, 4000K or 5000K in 90+ CRI. LED modules and drivers are replaceable.
Color accuracy <3 SDCM

CONSTRUCTION

One piece extruded aluminum housing. Cast aluminum end caps.

OPTICS

Extruded High Transmission Milky Acrylic Lens with No LED imaging. Extruded High Transmission Frosted Acrylic Lens with LED imaging.

ELECTRICAL

Fixture comes reassembled with 8" whip.
All Drivers are installed in remote location.
All drivers are Universal input 120-277 VAC.
Standard Constant Current drivers include 0-10V dimming preinstalled in enclosure.

LABELS

Conforms To UL STD 2108 Certified To CSA STD C22.2 # 250.0
Suitable for Dry or Damp Locations, indoor use only.
ETL Control # 5011600

Feed Points

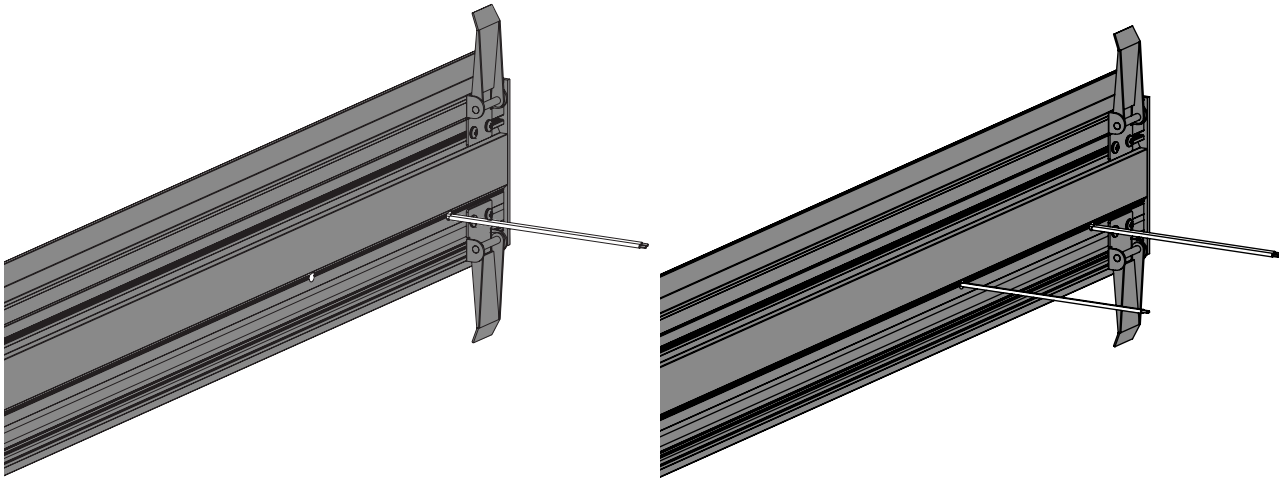

Rear Feed

Mounting Clips

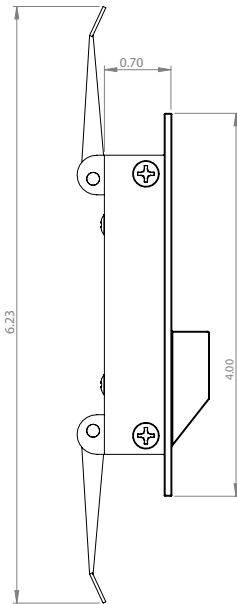

Flange Spring Clip

Patterns

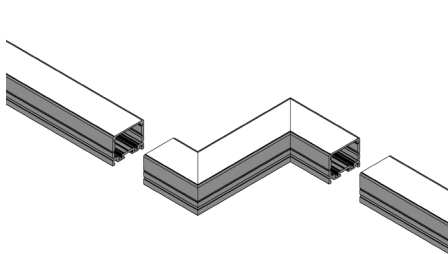

Custom patterns

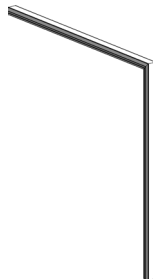

Changing elevations

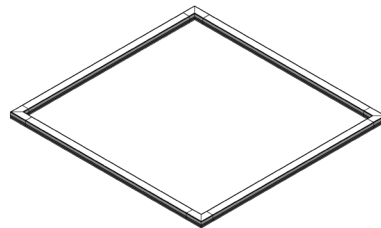

Coplanar surfaces