

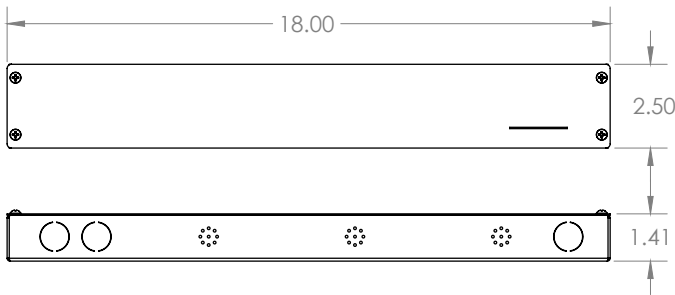

Features

- Compliant with Title 24 Requirements*
- Wireless RFID Programming - No power required
- 0-10V Dimmable - Dim Down to 0.1%
- Dim To 0 Capability
- NTC - LED Temperature Sensor
- Auxiliary Power Output
- Wide Operating Window
- CLO (constant lumen output)
- Up to 90% Efficiency
- Universal Input Voltage
- UL Listed 8750, Class 2, Class P

Line Work



Dimensions

Length :	18.00" [290.5mm]
Width :	2.50" [59.9mm]
Height:	1.5" [35mm]

Max Distance at Full Load @ 2000 mA

18 AWG	16 AWG	12 AWG
40 Feet	60 Feet	150 Feet

Quick Specs

VOLTAGE	WATTAGE	AMPERAGE	INPUT VOLTAGE
3-50VDC	100	2	120 - 277 AC
CLASS	EFFICIENCY	DIMMABLE	WARRANTY
2	>90%	0-10 0.1%	5 Years

Approvals

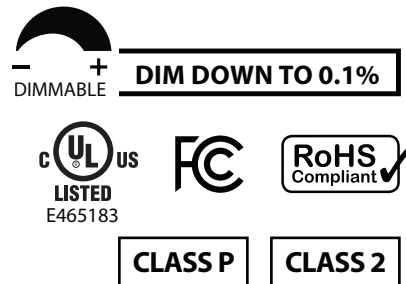

Wirings

Input :	8" - Black [L] - #18AWG
	8" - White [N] - #18AWG
	8" - Purple [0-10] - #18AWG
	8" - Grey [0-10] - #18AWG
Output :	8" - Red [DC +] - #18AWG
	8" - Black [DC -] - #18AWG

Max Driver Load at 2000 mA

2.5w (85ma)	5.0w (145ma)	10.0w (250 ma)
23 Feet	13 Feet	8 Feet

Driver Anatomy

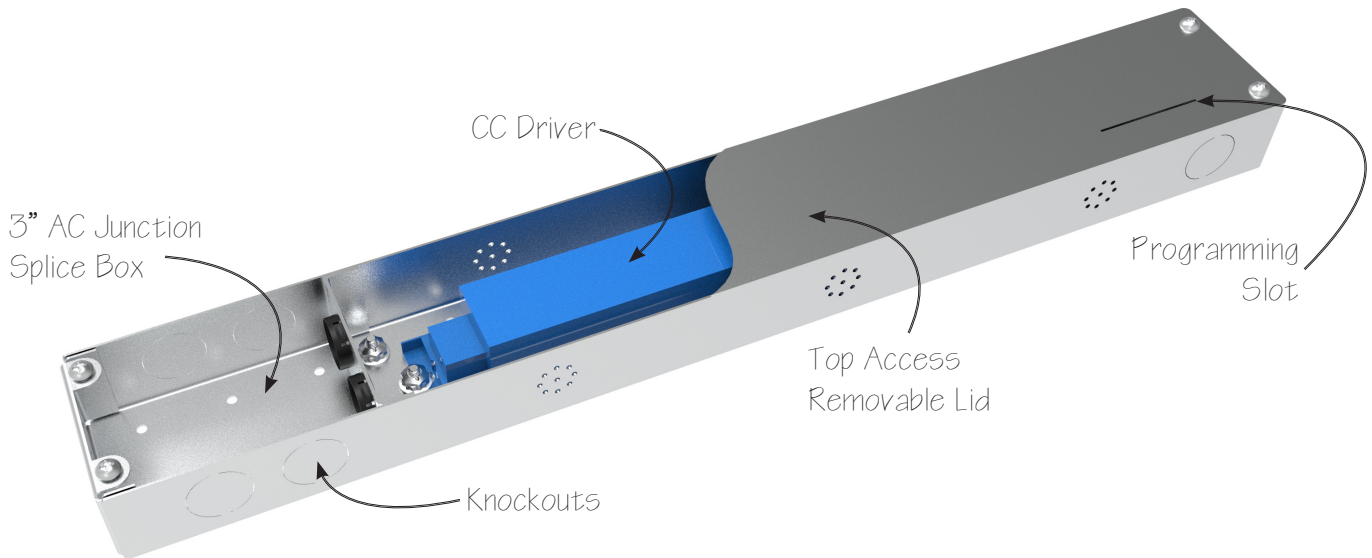

Input

Input Voltage Range	120 - 277 VAC
Input Frequency	50 / 60 Hz
Input Current	1.2A@120VAC / 0.5A@277VAC
Inrush Current	38A Max (refer to graph, page 10)
Efficiency	> 90% (refer to graph, page 6)
Power Factor	0.99@120VAC / 0.98@277VAC (refer to graph, page 7)

Output

Output Voltage Range	3-50 VDC
Output Current Range	100 - 2000mA (1mA Step Programmable)
Output Current Tolerance	+/- 5%
Output Current Ripple	+/- 5% Max Load
Line Regulation	+/- 5%
Load Regulation	+/- 5%
Turn On Delay Time	0.4 sec @ Max Load
Sensor Power Supply (Auxiliary)	12v / 24v up to 160mA (Programmable)
Stand-By Power	< 1W

Environmental

Env. Protection Rating	IP21 - Indoor Use Only
Surge Protection	2.5 KV
Operating Ambient Temperature	-40°C - +60°C
Operating Temperature	-40°C - +75°C
Storage Temperature	-40°C - +85°C
Expected Life Time	50K hours at 75°C (refer to graph, page 10)
EMI Compliance	FCC 47CFR Part 15 Class B
Audible Noise	< 24db Class A
Withstanding Voltage	2.5 KV

Certificates/Approval signs	UL 8750 class 2, class P
-----------------------------	--------------------------



Dimming

Dimming Control	0-10 Volt
Dimming Input Range	-2V +/- 15V
Dimming Curves	Linear / Logarithmic (Programmable)
Min. Dimming Level	Dim down to 0.1%
Dim to Off	Yes (Programmable)
Current Consumption	0.35mA / Source
PWM Dimming	2000Hz

LED Thermal Protection

NTC Value	15 k \pm 5% @25 ^o c Manufacturer P/N: NTCS0805E3153JMT
Output Level Range	1mA step programmable (0 - 100%)

Protections

Over Current Protections	Yes; current limit
Short Circuit Protections	Yes; hiccup mode
Over Voltage Protection	Yes; hiccup mode
Over Temperature Protection	Yes; power derating (refer to graph, page 9)
Mis-Wiring Protection	Yes; auto shutdown

Mechanical & Housing

Length	18"
Width	2.5"
Height	1.5"
Housing Material	Aluminum 20 AWG
Junction Box	Yes - 3" AC JBox and DC JBox
Input Connectors Type	black & white / Wago / 16-20AWG strip 3/8"
Output Connectors Type	red & blue / Wago / 16-20AWG strip 3/8"
Dimming Connectors Type	purple & gray / Wago / 16-20AWG strip 3/8"
Auxillary Connectors Type	yellow & gray / Wago / 16-20AWG strip 3/8"
NTC Connectors Type	orange & orange / Wago / 16-20AWG strip 3/8"
Mounting	#8 Screw Mounting Holes



Flicker Performance

The IEEE P1789 flicker test results are presented graphically with no observable effect (green area), low-risk (yellow area), and high risk (red area).

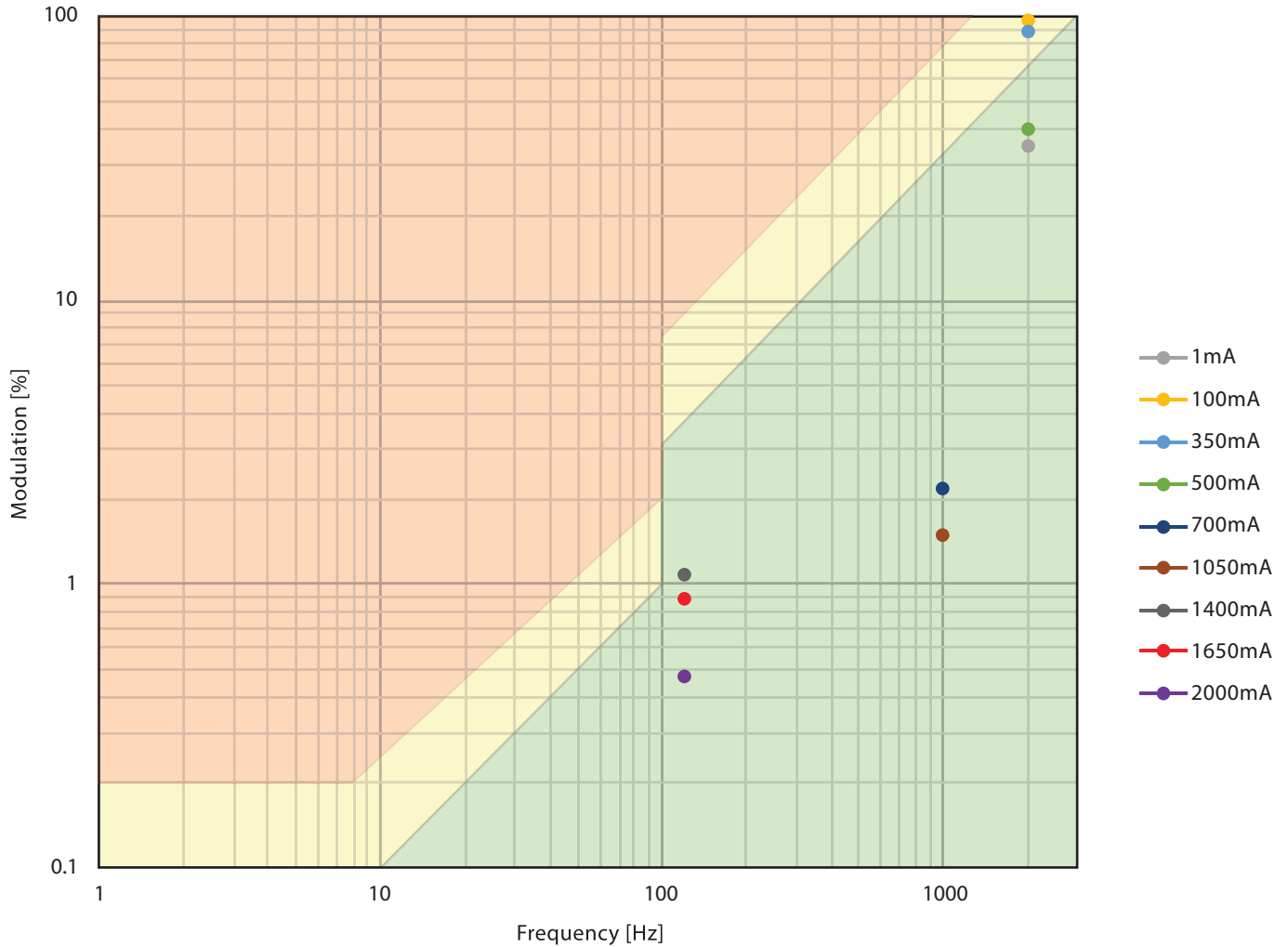

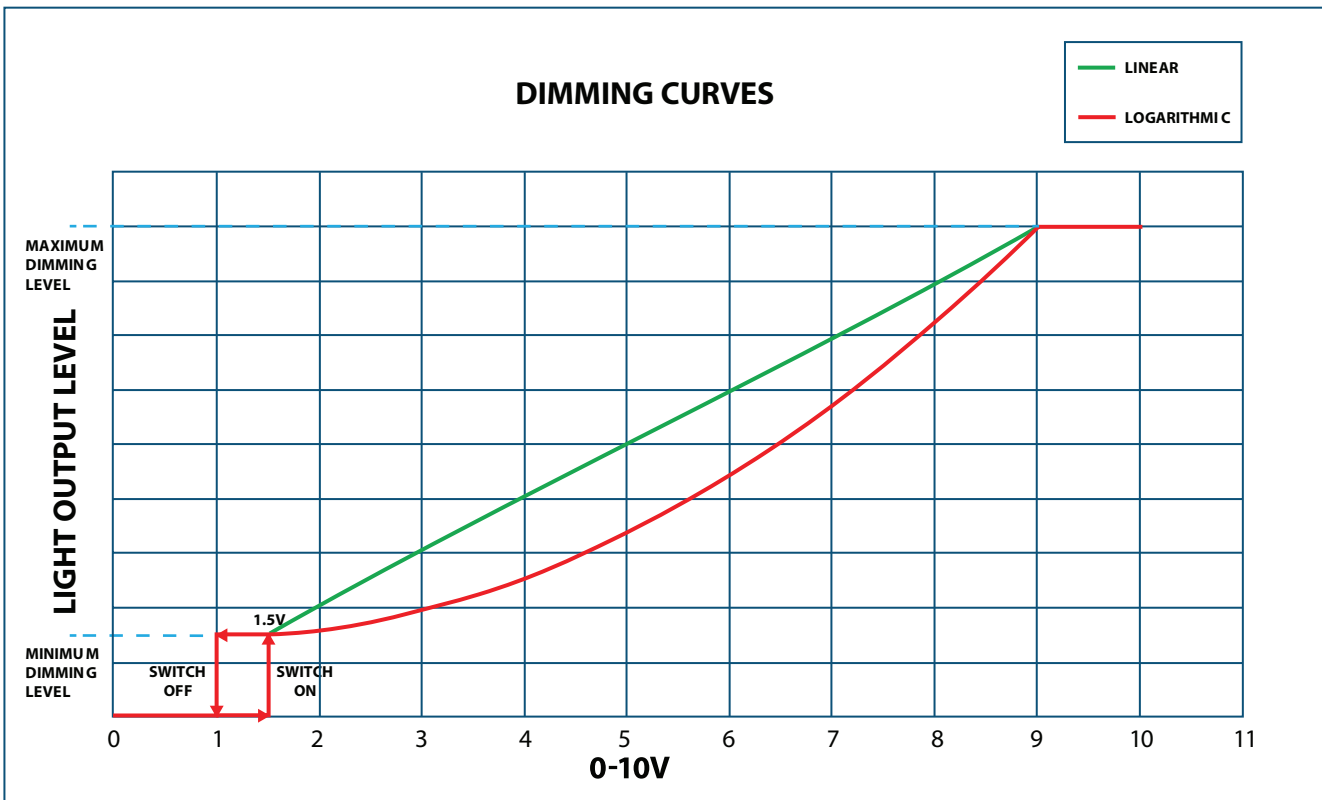
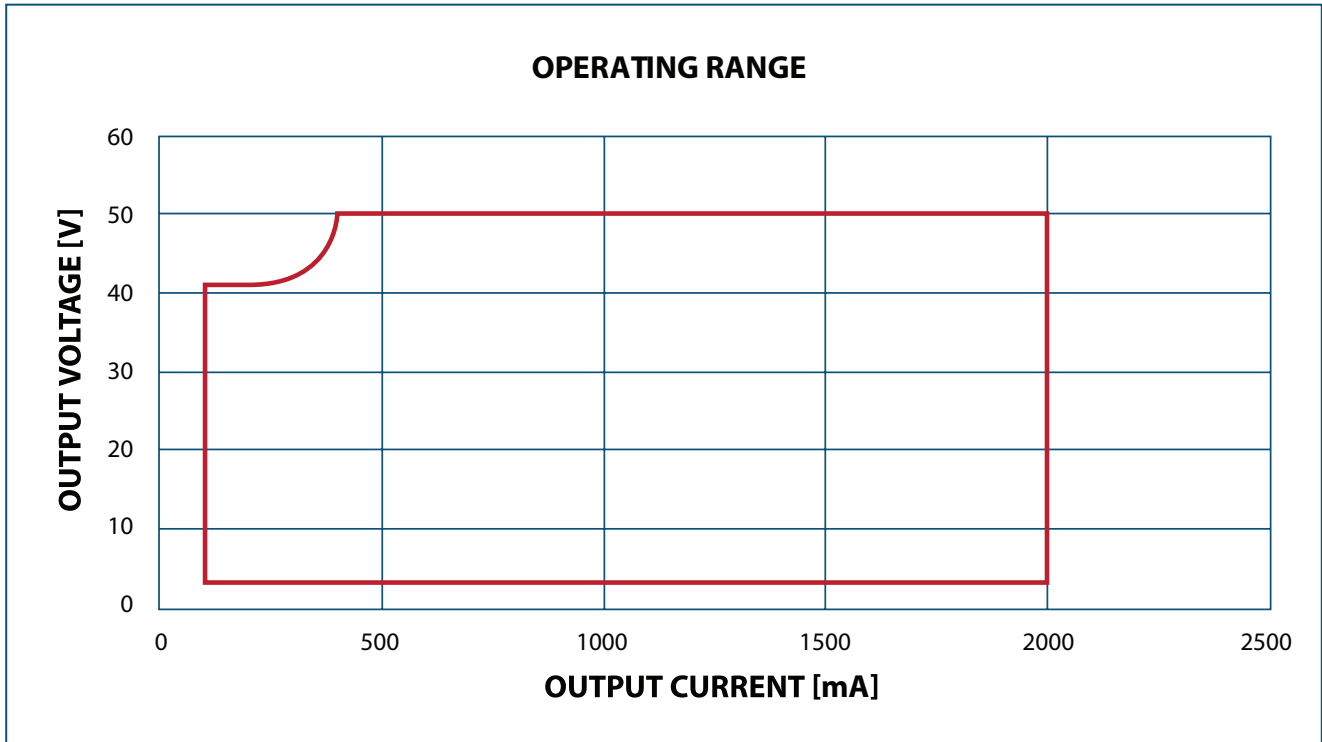

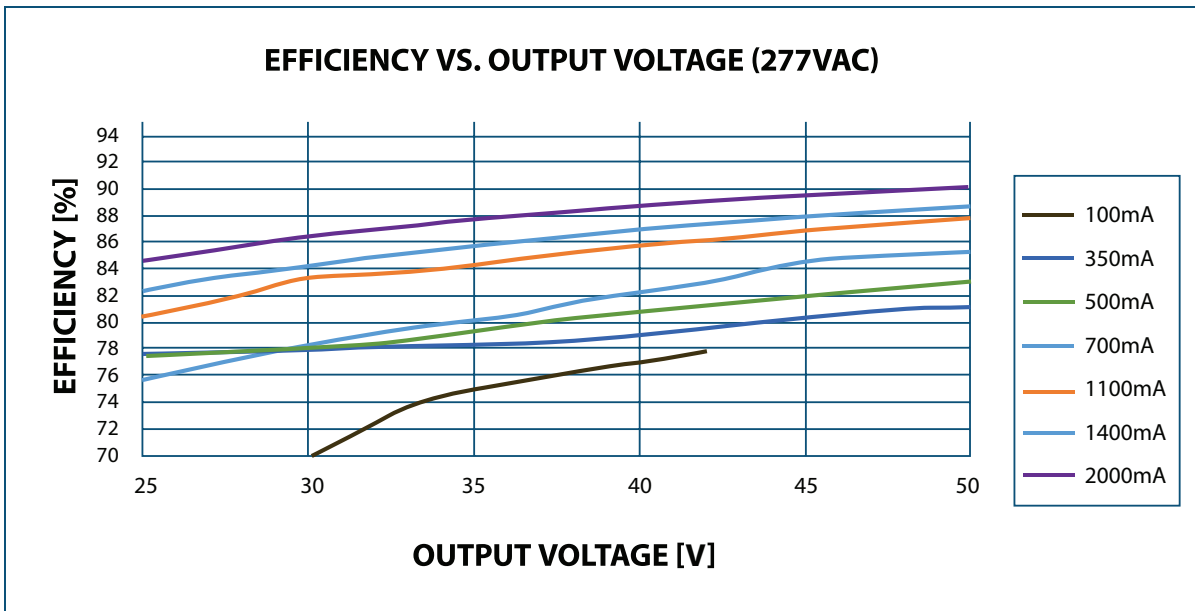
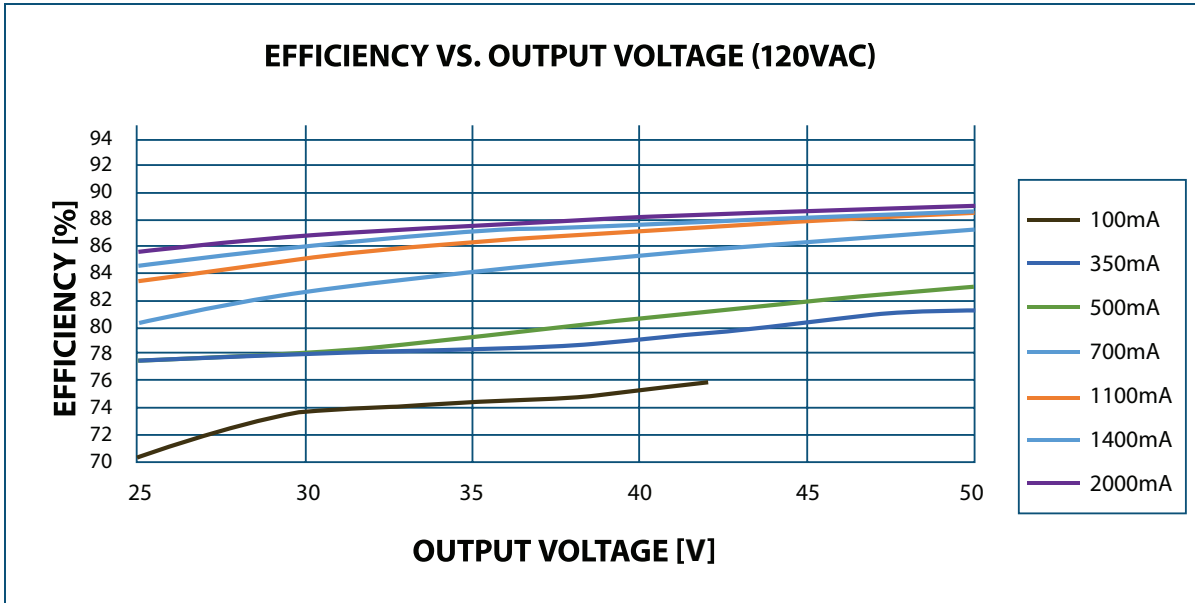

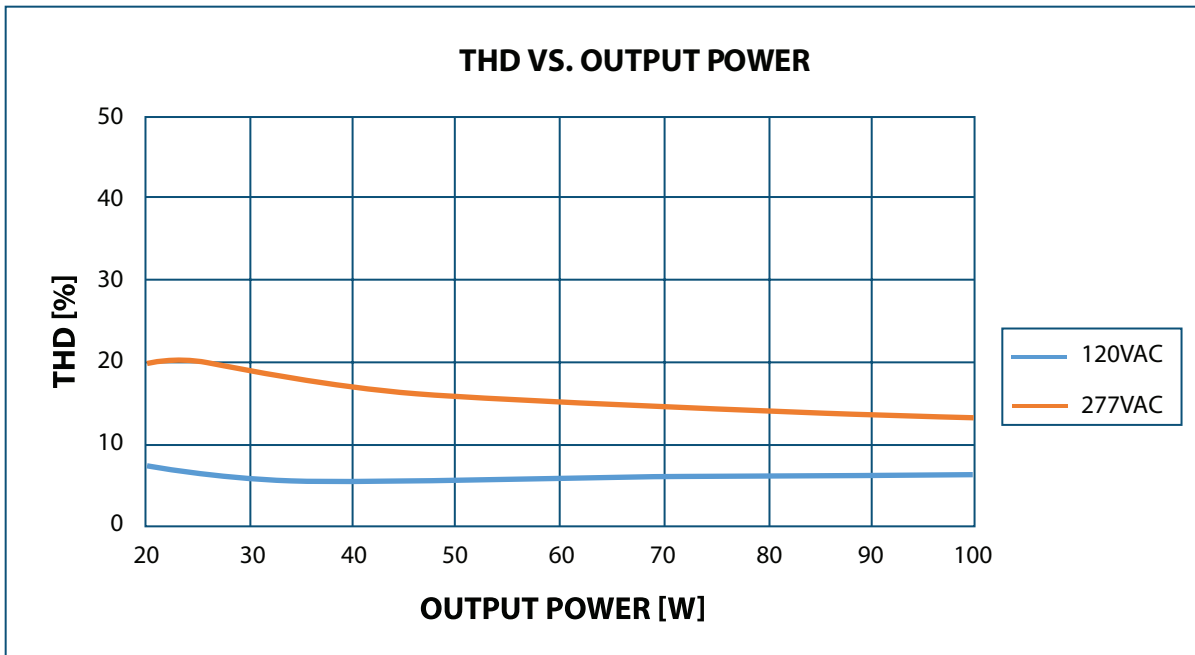
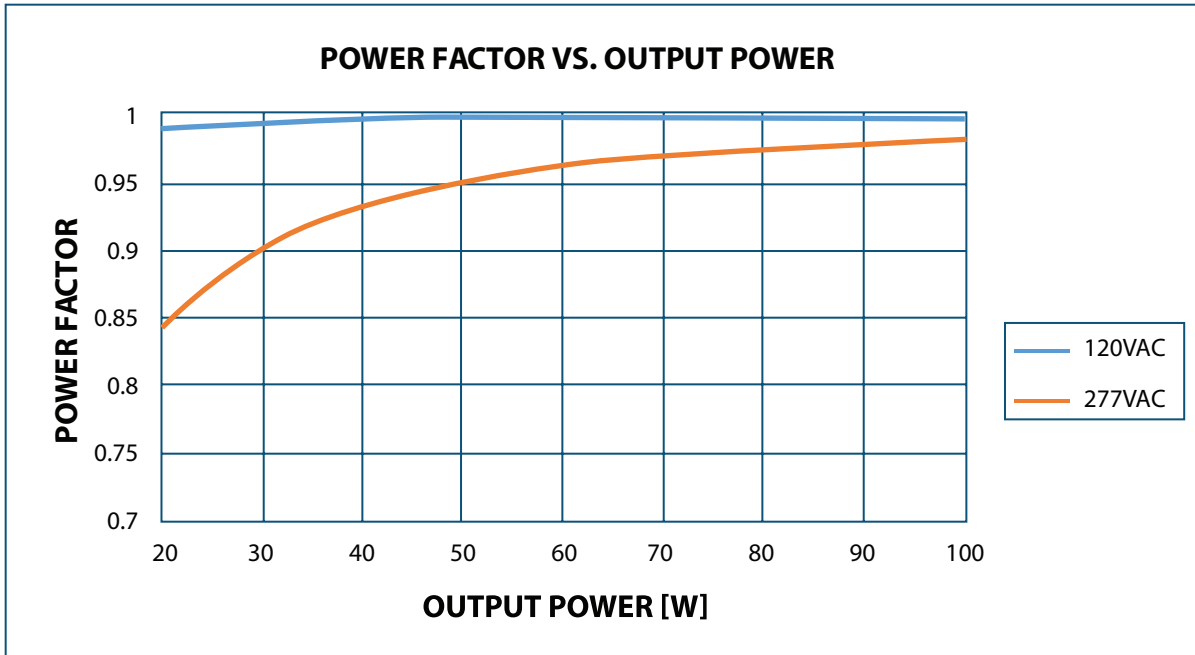

LED THERMAL PROTECTION NTC

The driver helps protect the LED's lifetime and will reduce the temperature of the LED module by derating the output current in case of high temperatures.

The negative temperature coefficient (NTC) thermistor must be connected to the LED driver as shown in the wiring diagram.

For maximum performance, the NTC thermistor must be placed close to the Tc point of the LED module.

The power derating parameters can be programmed using the FlexTool programmer. The NTC outputs can be left disconnected if thermal protection is not required.

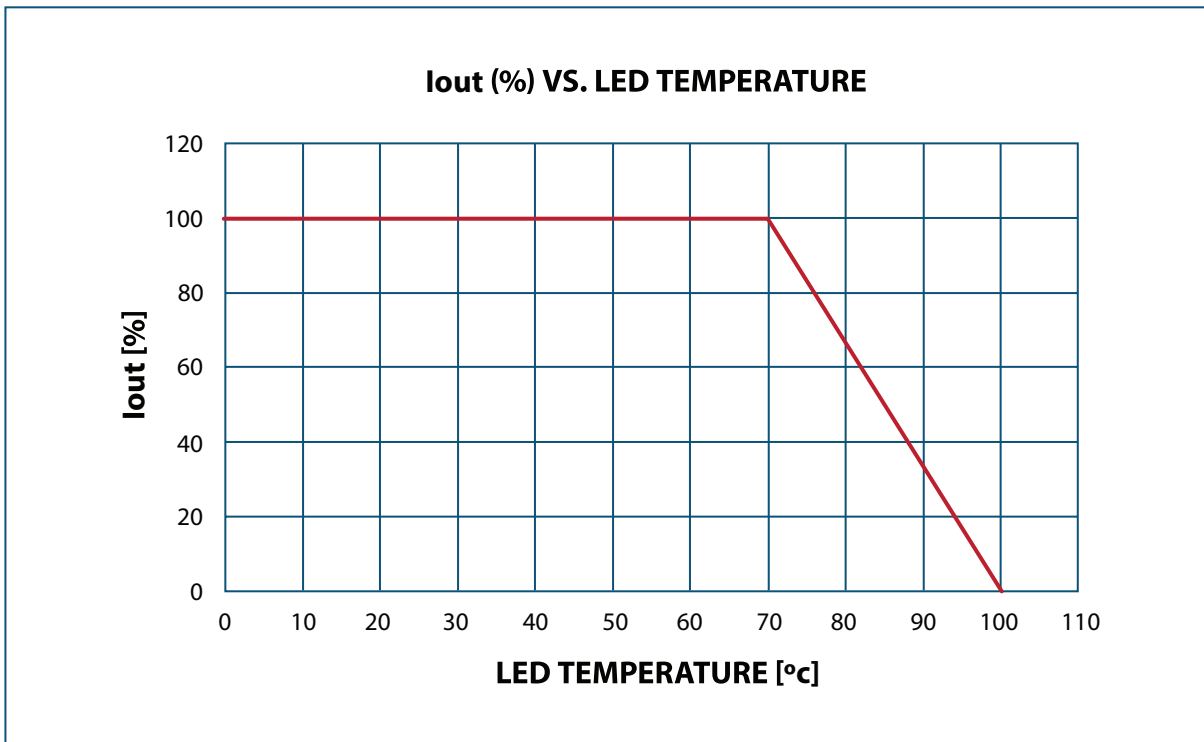
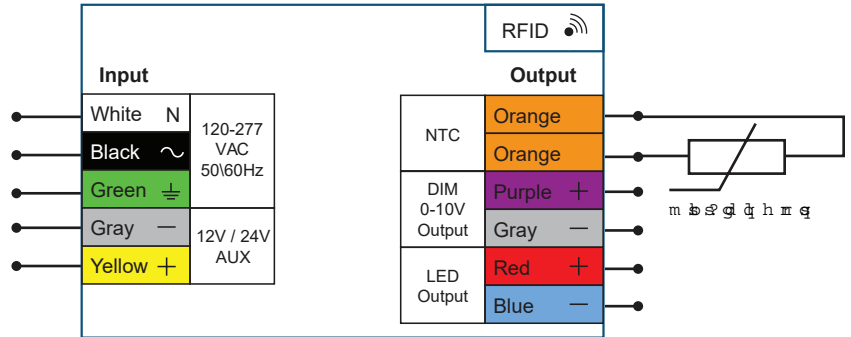



DRIVER THERMAL PROTECTION

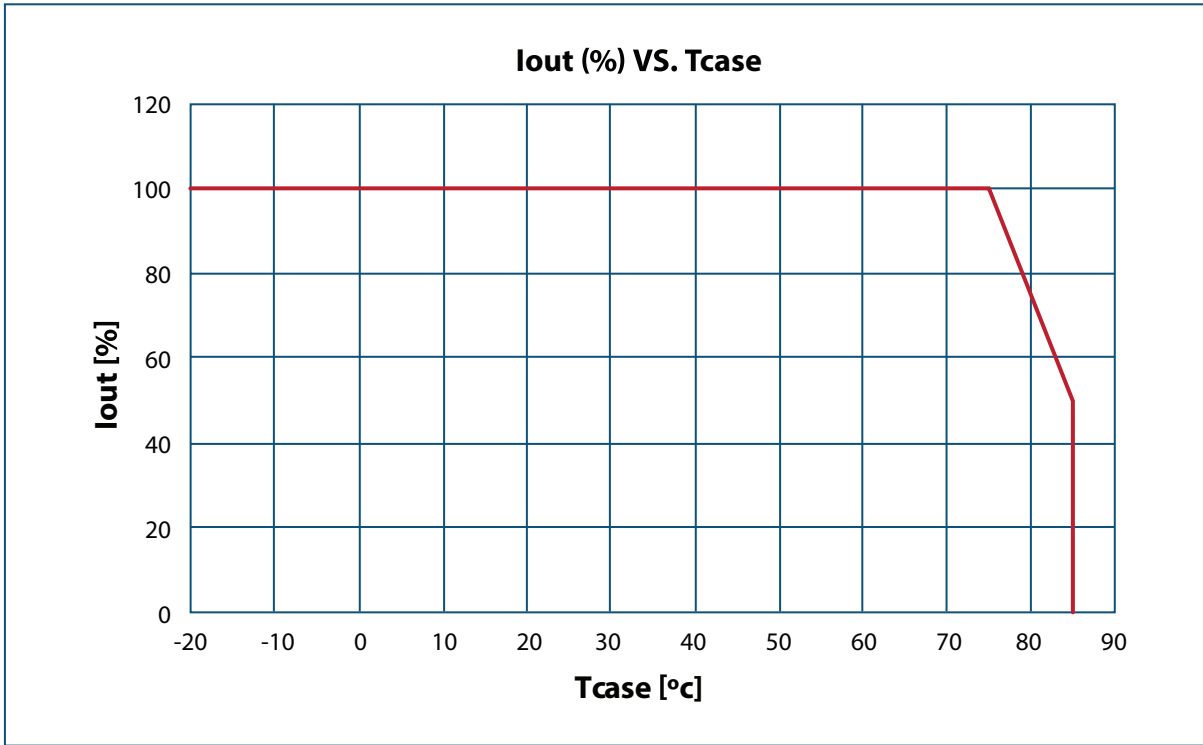

	MinM	ax
Normal operation	-40°C	+75°C
Derating area	+75°C	+85°C
Protection area	+80°C	
Return to work after thermal protection activated	+70°C	

5% LED drop allowed			
AWG	100-700mA	700-1650ma	1500-1200ma
18	17 ft	7 ft	6 ft
16	27 ft	12 ft	9 ft
14	42 ft	19 ft	15 ft
12	67 ft	36 ft	24 ft

10% LED drop allowed			
AWG	100-700mA	700-1650ma	1500-1200ma
18	34 ft	15 ft	12 ft
16	53 ft	23 ft	19 ft
14	85 ft	37 ft	30 ft
12	135 ft	59 ft	47 ft



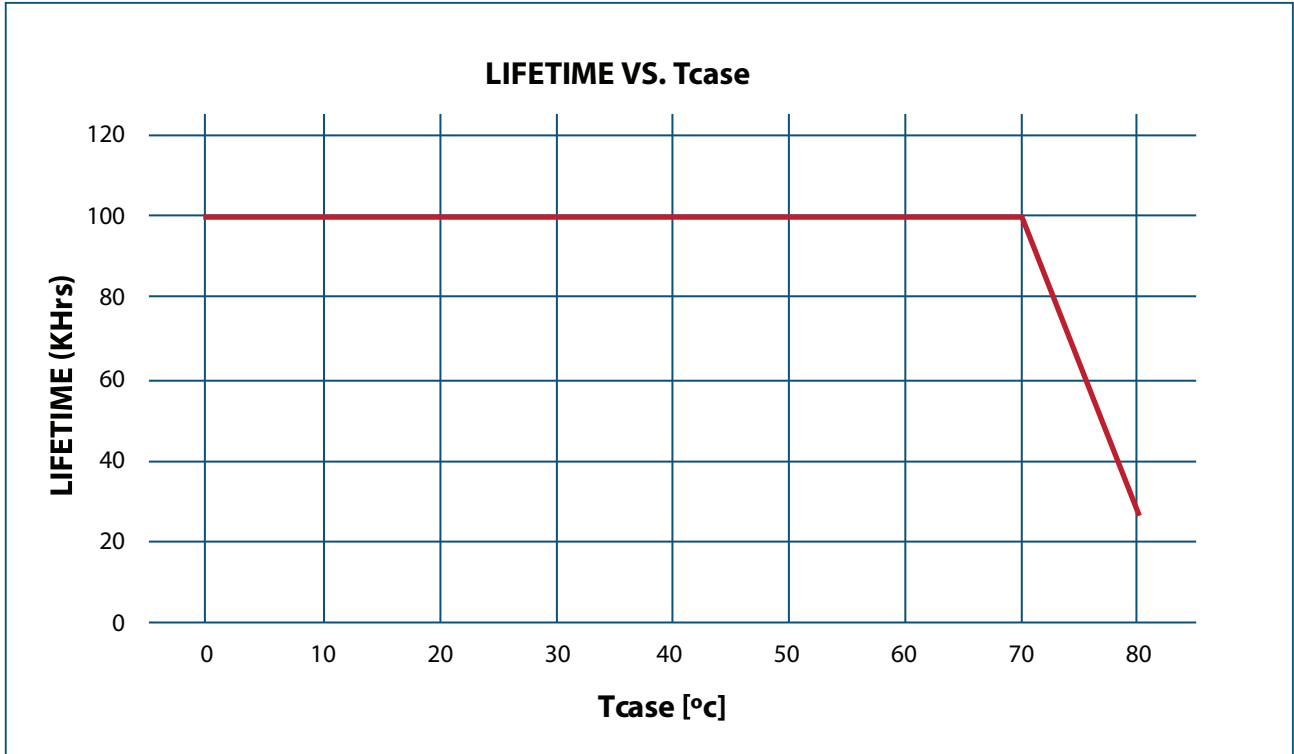

INRUSH CURRENT

Vin [V]	Ipeak [A]	T (@50% Ipeak)
120 VAC	14.2	1.5 usec
277VAC	38	1.2 usec

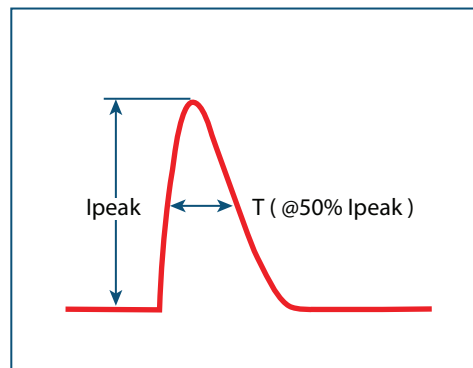



REMOTE INSTALLATION

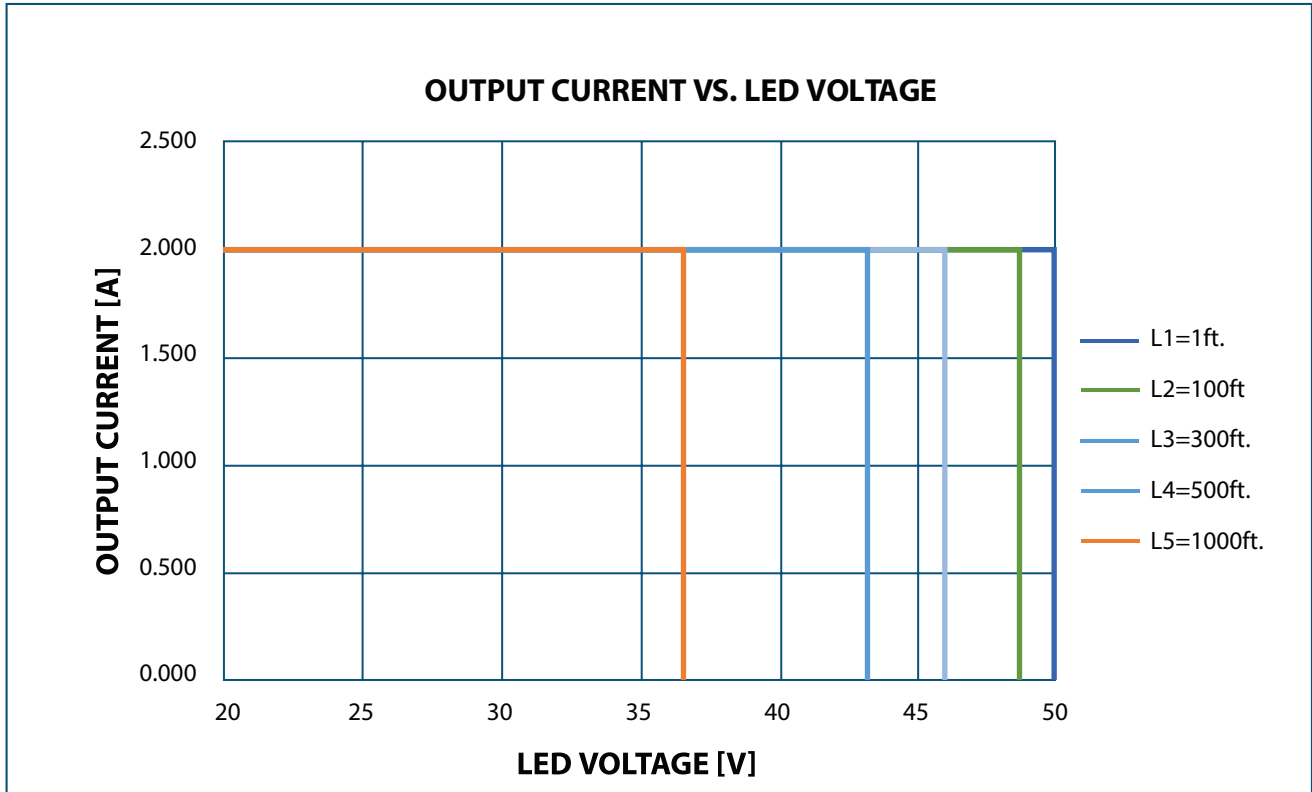

Test Condition:

- 1. Output Power = 100W
- 2. Output Current : 2A
- 3. Wire Parameters = 18AWG, 16/30, 6.75Ω/1000'

Note - Above L=100ft. min LED voltage = 10v

